

Released SOL Test Questions
Sorted by Topic
Compiled by SOLpass – www.solpass.org
SOL 4.6 Weather

- weather measurements create a record that can be used to make weather predictions;
- common and extreme weather events affect ecosystems; and
- long-term seasonal weather trends determine the climate of a region.

AIR MASSES AND FRONTS

- Which type of **storm** causes the most **flooding** in areas located near an **ocean coastline**?
 - Tornado
 - Hurricane
 - Blizzard
 - Freezing rain
- Which of these best describes a **tornado**?
 - A winter storm that produces frozen precipitation
 - A rotating funnel-shaped cloud with strong winds and thunderstorms
 - A severe weather condition with low temperatures and blowing snow
 - A storm that forms over warm ocean water and has extremely strong winds

Rain, Snow, Sleet

- Which weather term best describes the words above?
 - Humidity
 - Atmosphere
 - Precipitation
 - Barometric pressure
- Certain storms form **over water** near the equator, usually between the months of June and November. Warm, moist air rises quickly over the ocean, causing a **strong, whirling** storm with high winds and heavy rains. This type of storm is known as a —
 - tornado
 - hurricane
 - blizzard
 - sandstorm
- Which factor is usually recorded when gathering weather data?
 - Number of gases in the air
 - Temperature of the air
 - Type of gases in the air
 - Amount of air in an area

CLOUD TYPES

- Different types of clouds are associated with different types of weather. Which of the following types of **clouds** would most likely be seen in the sky during a **thunderstorm**?

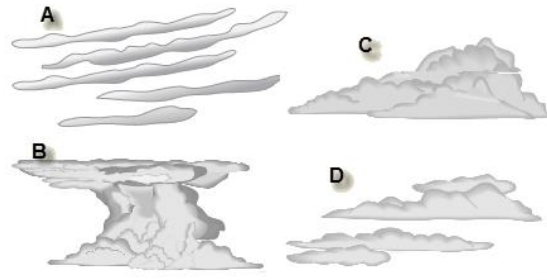

- Tornadoes** are most likely to be produced from which type of cloud?
 - Cirrus
 - Stratus
 - Cumulus
 - Cumulonimbus



- Usually, **cumulonimbus** clouds are associated with weather that is —
 - dry
 - stormy
 - fair
 - foggy

METEOROLOGICAL TOOLS

- Which of these instruments would be used to measure **wind speed**?

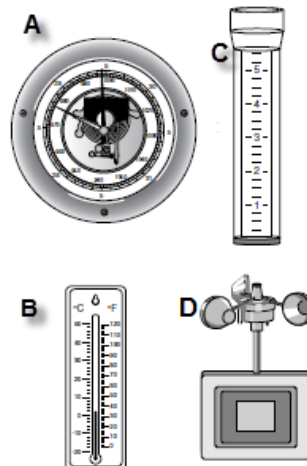

10. The simple instrument shown is used to measure —

- a. air pressure
- b. wind speed
- c. temperature
- d. precipitation

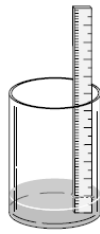

11. If this device was placed outside, it could be used to show —

- a. changes in temperature
- b. the amount of rainfall
- c. changes in humidity
- d. the speed of the wind

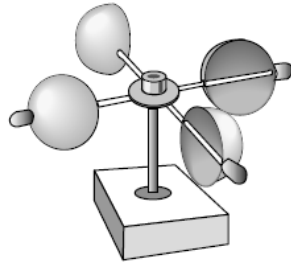

12. Which instrument could tell you that conditions are right for flying a kite?

- a. Anemometer
- b. Barometer
- c. Hygrometer
- d. Thermometer

13. Which do meteorologists use to measure the amount of **precipitation** that falls during a storm?

- a. Anemometer
- b. Barometer
- c. Rain gauge
- d. Weather vane

14. Which of these instruments measures **wind speed**?

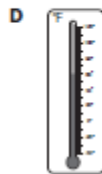
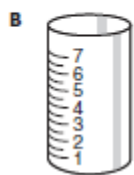

Classroom Barometer

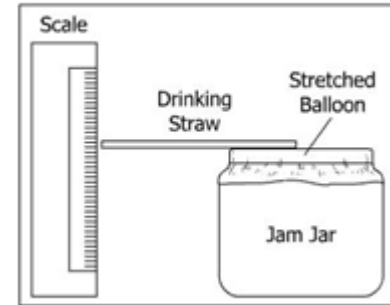

15. Students made a classroom barometer that can be used to measure-

- a. wind direction
- b. temperature
- c. air pressure
- d. precipitation